

DO-IT-YOURSELF SEPTIC SYSTEM INSPECTION FIELD GUIDE (GRAVITY SYSTEM)

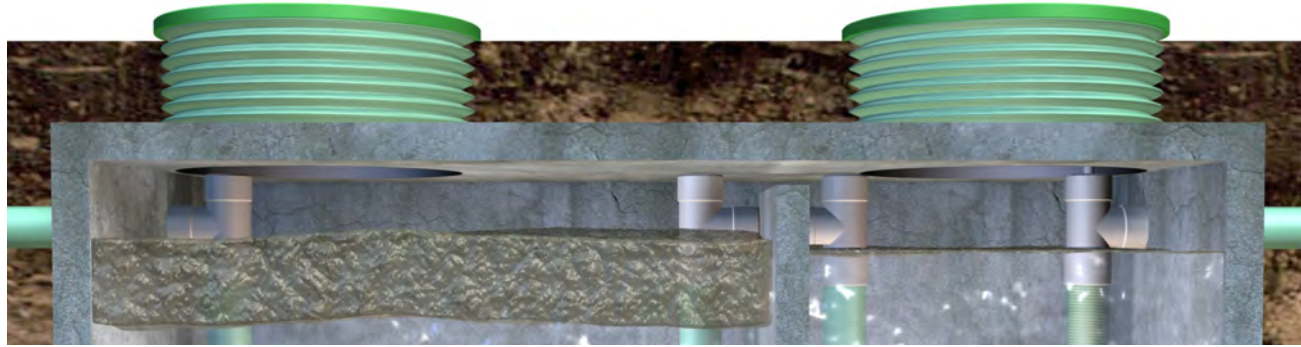



DISCLAIMER

Septic system owners are ultimately responsible for the operation, monitoring, and maintenance of their onsite septic system. Washington State and local public health regulations require septic system owners to have a complete evaluation of their septic system performed every one to three years (depending on the type of system) and to report the condition of their system to the local health jurisdiction.

The do-it-yourself (DIY) septic system inspection training program is designed to teach homeowners how to perform a basic inspection of their home septic system. If the homeowner finds that their system is malfunctioning, it will be necessary for them to contact a licensed professional with the necessary skills and equipment to repair the system. Septic system repairs require a permit from the local health jurisdiction and must conform with state and local public health codes that regulate septic system repair. This program is not intended as training for onsite professionals or for the inspection of community or commercial septic systems. Any mention of trade names, private companies, or commercial products in this training program is for illustrative purposes and does not constitute an endorsement.

Inspecting or maintaining a septic system can be dangerous. If you choose to inspect or maintain your septic system, you do so at your own risk and are personally responsible for your own safety. You may be exposed to health hazards including, but not limited to, infectious diseases, hazardous gases, and electrical shock. Sewage carries harmful bacteria, viruses, and parasites that can cause infection and illness, especially in people with weakened immune systems, pregnant women, children, and the elderly. Proper hygiene, protective clothing, and safe work practices help reduce exposure risks. A homeowner performing a DIY septic system inspection is responsible for taking all necessary precautions to minimize the risks of illness or injury associated with the inspection or maintenance of the system.

If at any time you are concerned about your ability to safely inspect or maintain your septic system, you should stop what you are doing and hire a licensed professional to perform the work. Contact your local health jurisdiction for a list of licensed professionals working in your area.

In consideration for using this field guide, you understand and agree that Trevac, its officers, employees, agents or volunteers are not liable or responsible for any injuries or damage which may result from your using the materials or ideas, or from your performing the procedures depicted in this field guide. If you do not agree, do not use this guide.



CONTENTS

Introduction	4
Identify The Parts Of Your System	5
Locate Your Septic System	6
Inspection Tools & Materials List	7
Making Your Scum Stick	8
Making Your Sludge Stick	9
Septic Inspection Safety	10
Inspecting A Septic Tank	11 - 18
Inspecting A Gravity Drainfield	19 - 20
Inspecting A Distribution Box (D-Box)	21 - 22
Cleaning Up	23
Septic Care	25
Glossary of Terms	26 - 28
Attribution	29

INTRODUCTION

This field guide is intended to accompany the “Do It Yourself” (DIY) septic system inspection video and is to be used after viewing the video. Homeowners should have the field guide in hand during the inspection of their septic system. Checklists are provided in the guide to help homeowners go through each step of the process. Once the inspection process is complete, homeowners can use the field guide’s checklists to report their results to their local health department.

The training video and this field guide depict on-site septic systems that have installed risers to make septic systems easily accessible for inspections. Risers greatly add to the ease of locating and inspecting your system. Riser installation is highly recommended if your system does not already have them.

When inspecting your septic system be sure to wear protective clothing (that is eye protection, gloves, sturdy outerwear and steel toed boots if possible). Use the proper equipment and decontamination procedures, and use caution to avoid injuries when excavating soil to uncover tanks and lifting heavy lids.

If you encounter any problems along the way, stop and call a professional.



IDENTIFYING THE PARTS OF YOUR SYSTEM

Note: Each component of your system may be located in separate areas of your yard. Not all systems have risers installed. Keep in mind that over the years many systems have changed and look different. Your system may have different types of components than pictured here. If you cannot find the components of your system or you are unsure which type of system you have, call your local health department.

Basic Gravity Septic System

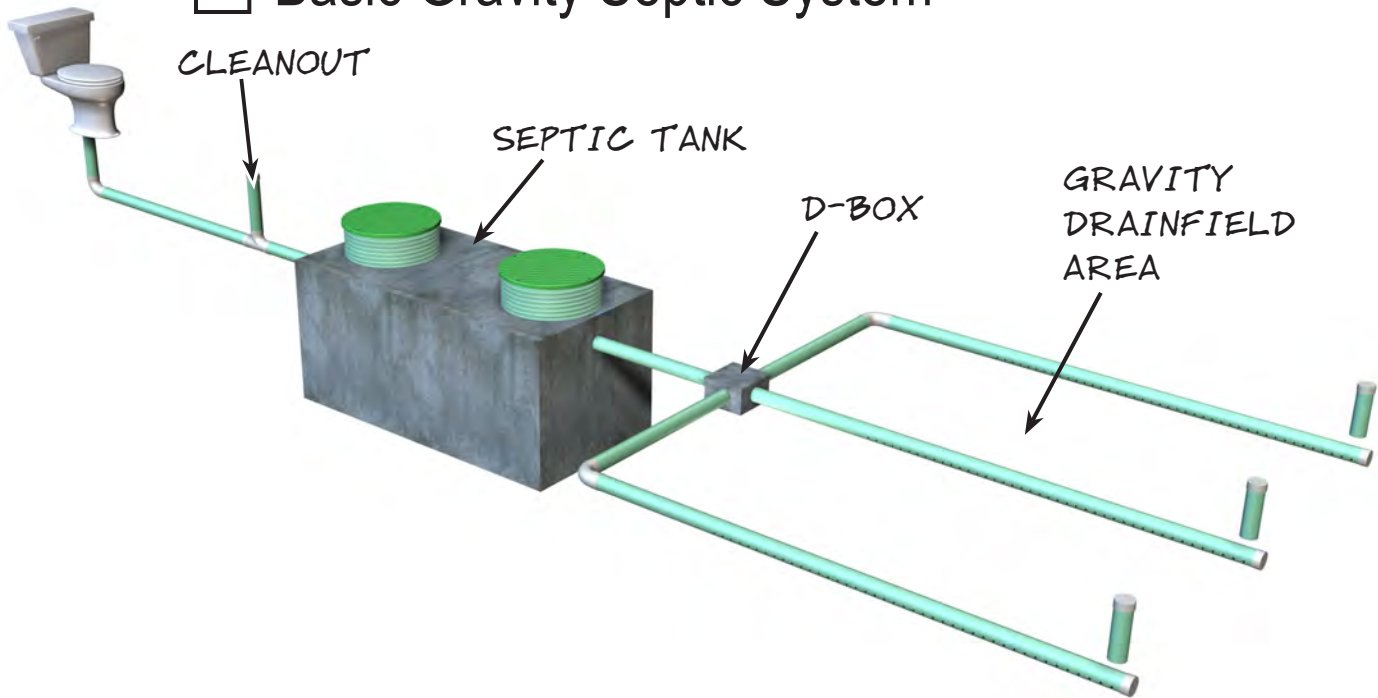

LOCATING YOUR SYSTEM

Three Ways To Locate Your System:

1. Look for lids or a series of lids in your yard.
2. Get your septic system "as-built" drawing from your local health department.
3. Call a professional to locate your system.

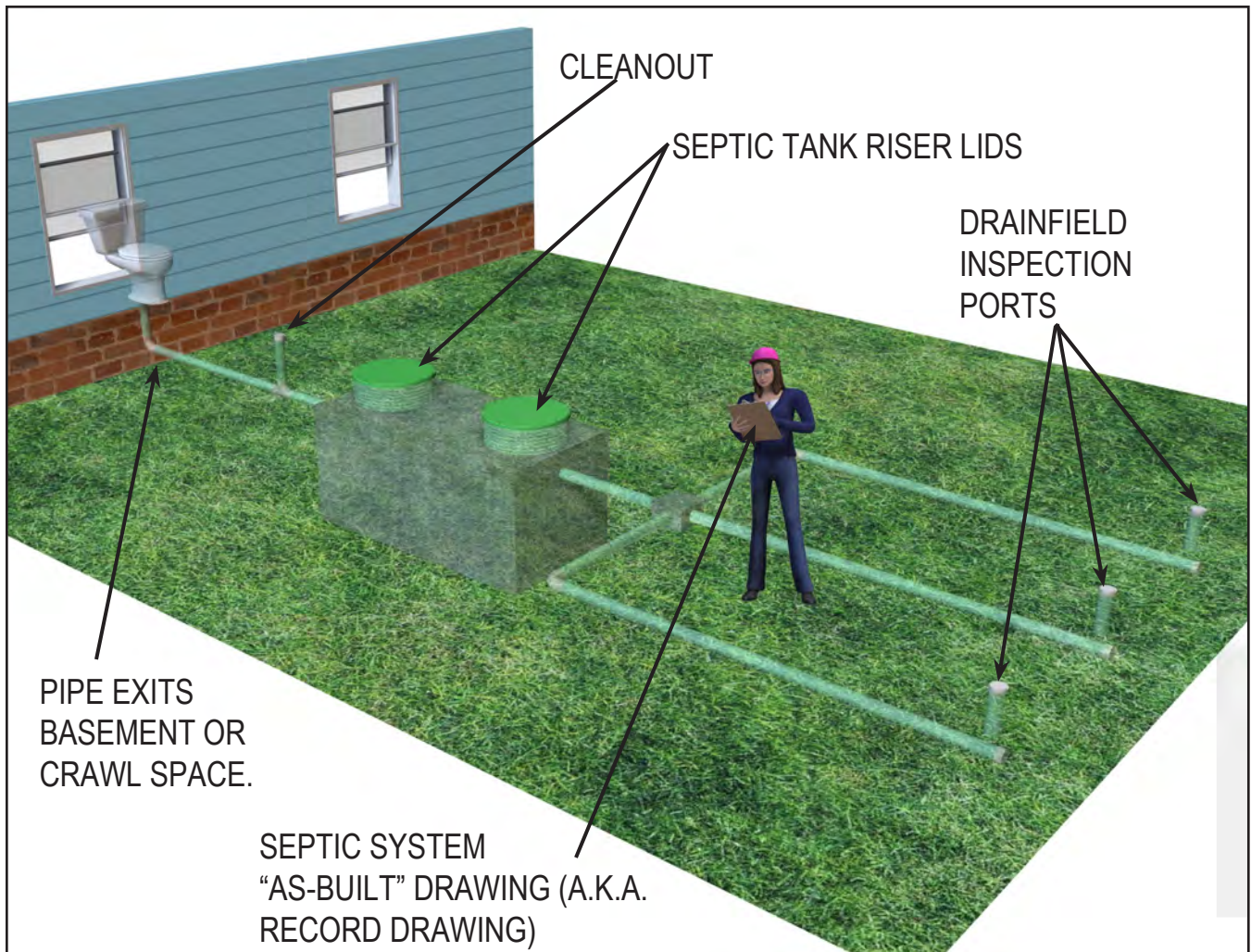

SEPTIC INSPECTION TOOLS & MATERIALS NEEDED

Materials List

- Plastic tarp
- Disposable rubber gloves (several pair)
- Safety glasses
- 5-gallon bucket
- Household bleach
- Spray bottle (to help with cleaning and sanitizing of equipment)
- Pencil
- Tape measure
- Cordless drill / screwdriver / Allen wrench to open lids
- Scum/sludge inspection sticks
- Pry-bar
- Shovel / trowel
- Garden hose hooked up to faucet
- Hand sanitizer
- Flashlight / head lamp

Inspection Stick Shopping List

- 2 10-foot sections of 1/2 inch PVC pipe
- 4 end caps
- 1 elbow joint
- 1 threaded coupler
- PVC cement
- 3 feet of white self-adhesive Velcro strip
- Pipe cutter or saw

MAKING YOUR SEPTIC INSPECTION TOOLS

Scum Stick Assembly

Materials:

1 10-foot section of PVC pipe, 1 elbow joint, 2 end caps, PVC cement.

- Using saw or PVC pipe cutter, cut a 6-foot section of PVC pipe.
- From the remaining 4 feet, cut a 6-inch section.
- Using PVC cement, connect the 6-foot and 6-inch section with the elbow joint.
- Install end caps using PVC cement.
- Final stick should look like a long capital "L".

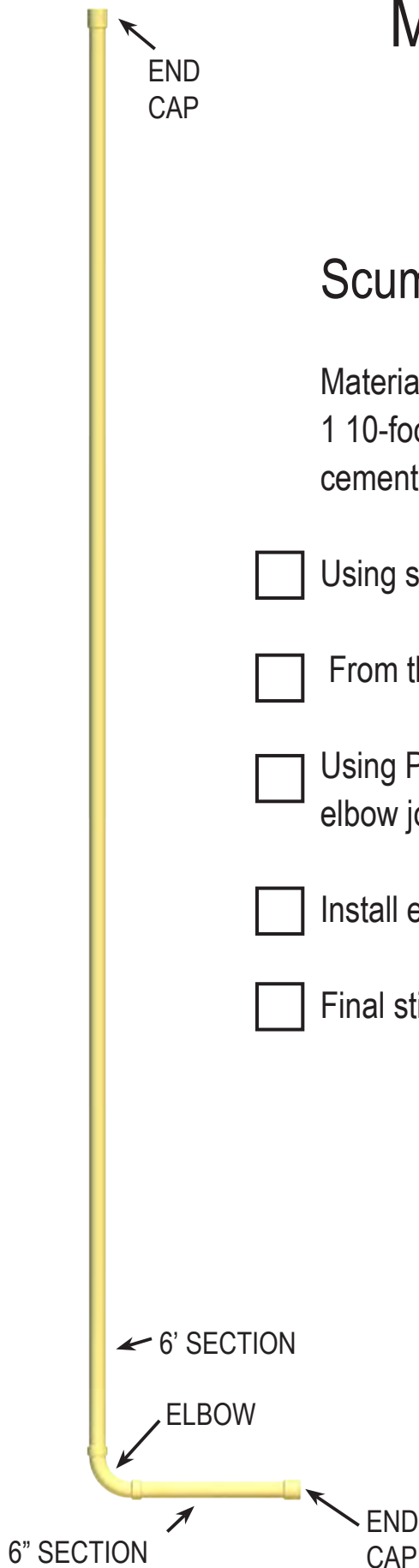

MAKING YOUR SEPTIC INSPECTION TOOLS

Sludge Stick Assembly

Materials: 1 10-foot section of PVC pipe, 1 threaded coupler, 2 end caps, PVC cement, 3 feet of white self-adhesive Velcro tape.

- Cut remaining 10-foot section in half, creating two 5-foot sections.
- Install one end of the threaded coupler to each section with PVC cement.
- Install end caps using PVC cement.
- Separate the Velcro tape. Discard the rough or “tooth” side.
- Remove the plastic backing from the 3-foot long Velcro tape. Starting at one end cap, adhere the soft or “loop” side of the Velcro tape up the length of the stick. This will be the bottom of the Sludge Stick. Make sure Velcro extends to the bottom of the stick (to the bottom of end cap), as shown.
- When cement is dry, connect the 2 5-foot sections with the threaded coupler.
- After use and cleaning, stick can be unscrewed for easier storage.

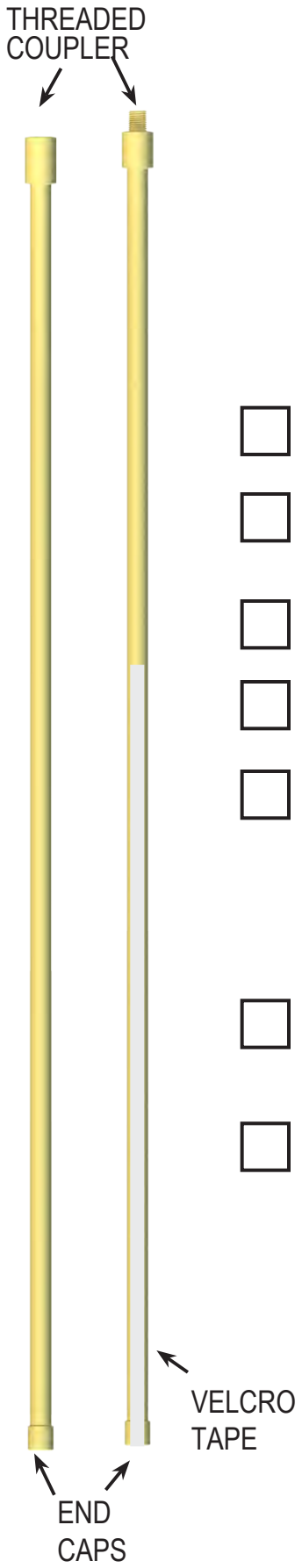

SEPTIC INSPECTION SAFETY

The Four “F”s Of Septic Inspection Safety:

1. FRIEND



ALWAYS INSPECT WITH ANOTHER PERSON PRESENT FOR SAFETY, ASSISTANCE AND TO AID WITH CHECKLIST.

2. FUMES



KEEP YOUR HEAD OUTSIDE OF TANKS. THE FUMES FROM SEPTIC TANKS ARE TOXIC AND CAN OVERWHELM YOU.

3. FALLING



KEEP TANK OPENINGS IN FRONT OF YOU. FALLS MAY OCCUR WHEN PEOPLE STEP BACKWARD INTO AN OPEN TANK. NEVER LEAVE AN OPEN TANK UNATTENDED.

4. INFECTION



AVOID TOUCHING YOUR FACE. RAW SEWAGE CONTAINS HARMFUL BACTERIA AND VIRUSES.

WEAR PROTECTIVE CLOTHING, GLOVES AND EYEWEAR AT ALL TIMES, CLEAN TOOLS AND CLOTHING WITH BLEACH.

SAFETY NOTES IN THIS FIELD GUIDE ARE SHOWN OUTLINED IN RED.

INSPECTING YOUR SEPTIC TANK

Common Septic Tank

Note: Some tanks will have plastic baffles, and others will have concrete baffles, depending on the age of the system.

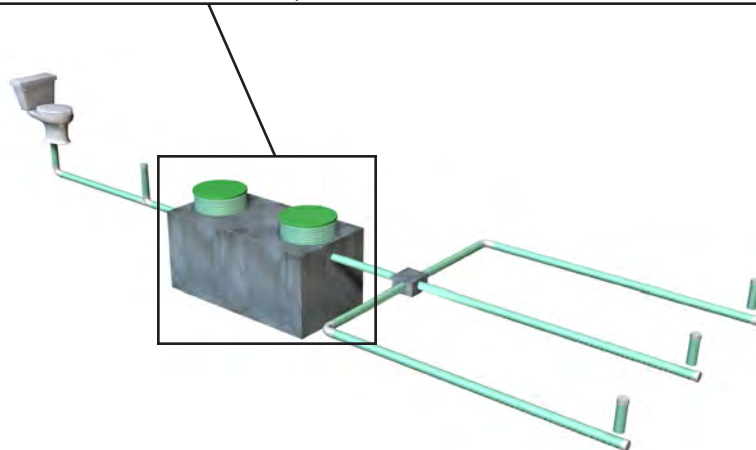
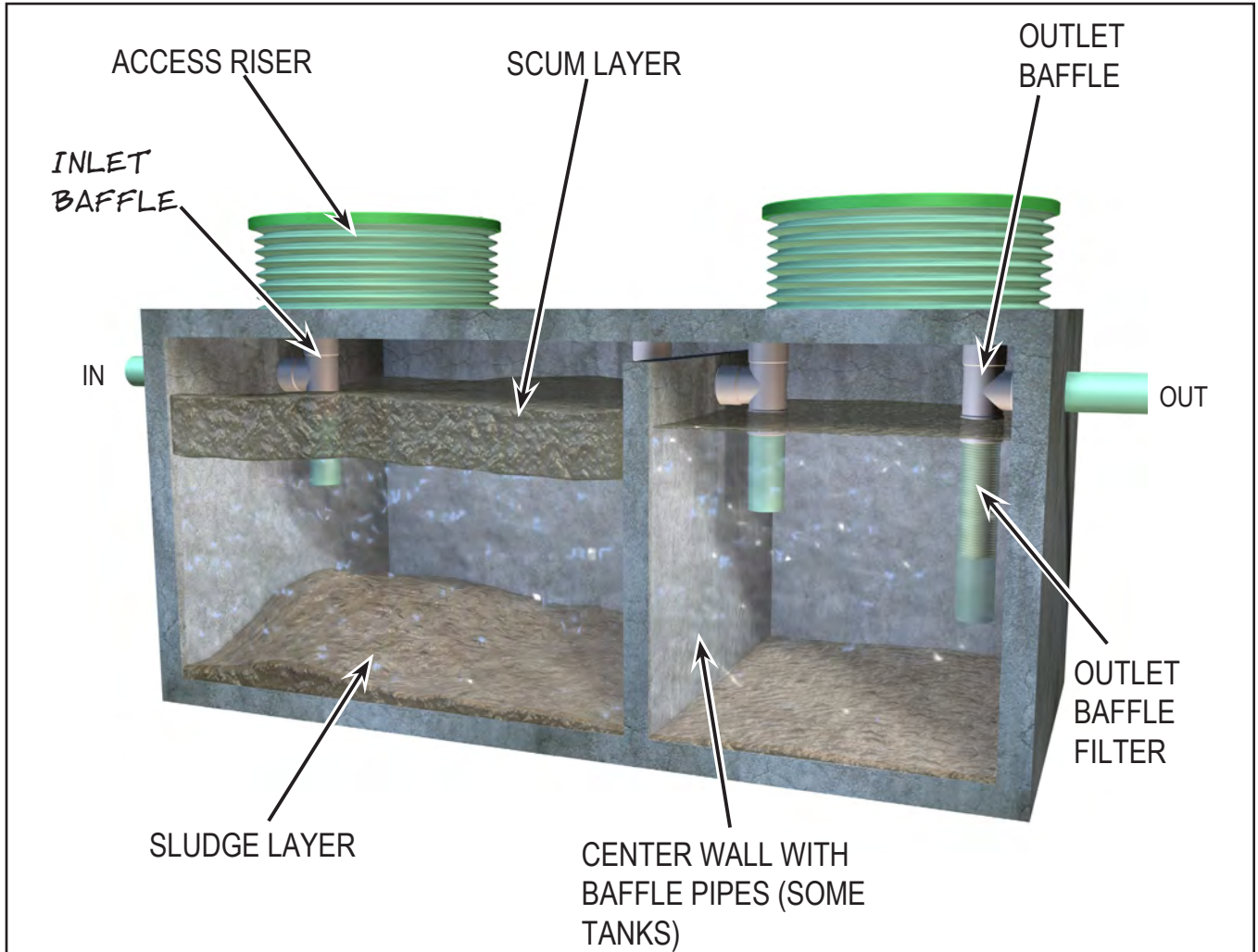

OPENING YOUR SEPTIC TANK

Note: If your tank has 2 chambers, perform all steps on both the inlet and outlet sides of the septic tank.

CHECK BOXES

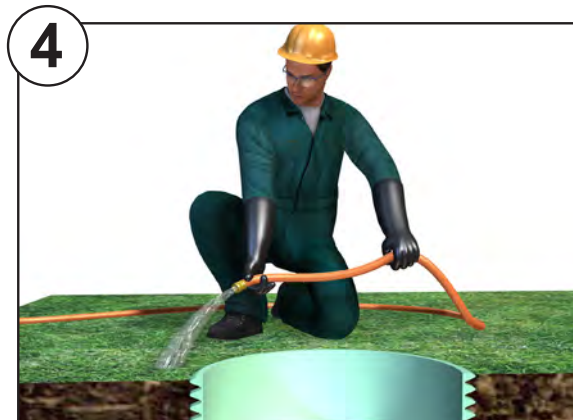
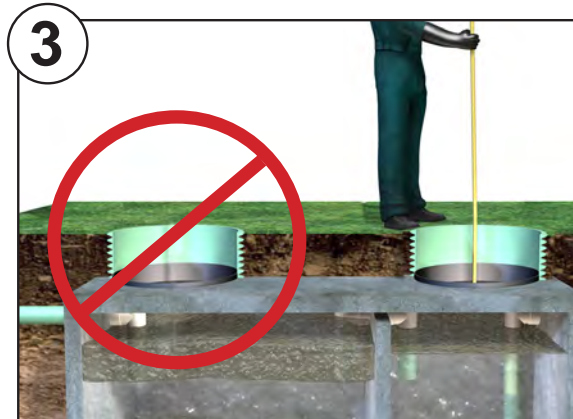
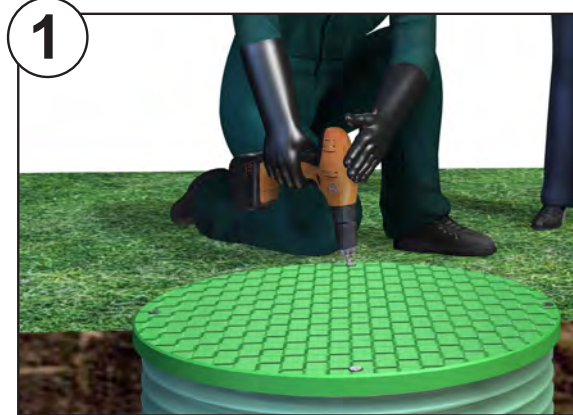

SAFETY CHECK: WEAR PROTECTIVE CLOTHING, EYE PROTECTION AND GLOVES. AVOID TOUCHING YOUR FACE.

SAFETY CHECK: INSPECT WITH ANOTHER PERSON PRESENT.

Clear away dirt and debris from access riser lid area. (Note: Some tanks do not have risers. Dirt will need to be removed to access tank. Use caution lifting lids.)

Remove riser lid.

Carefully remove inside lid if present (the lid may be very heavy and require prying, avoid back strain)

SAFETY CHECK: KEEP OPEN LIDS IN FRONT OF YOU. FALLS MAY OCCUR WHEN PEOPLE STEP BACKWARDS INTO AN OPEN TANK.

SAFETY CHECK: DON'T LEAVE OPEN TANKS UNATTENDED.

Check risers for watertightness. Run hose around outside of each riser to see if water seeps into tank. Does the riser appear to be watertight with no visible leaks?

Yes No Risers Not Present

IF YOU ANSWERED "NO" TO ANY OF THE ABOVE QUESTIONS, STOP YOUR INSPECTION AND CONTACT A PROFESSIONAL.

IS YOUR TANK WORKING PROPERLY?

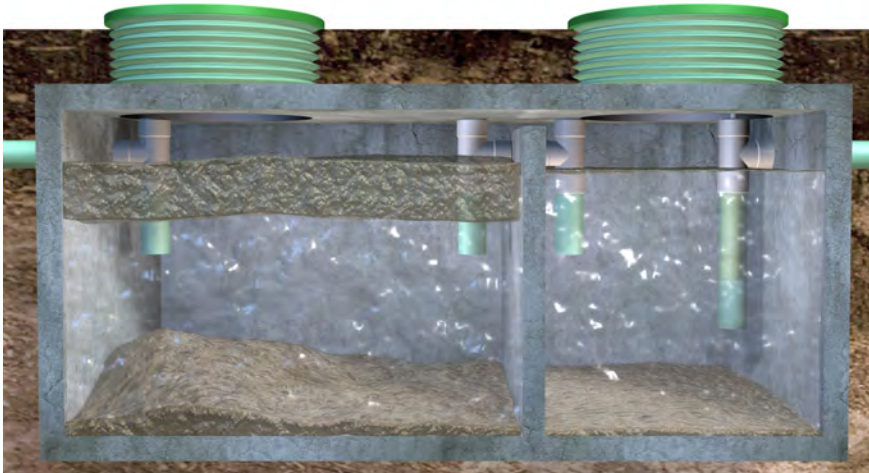

Normal

Scum layer should look like rich, living soil and only have mild odors. The liquid level should be even with the base of the outlet pipe.

If the tank looks normal, continue with inspection.

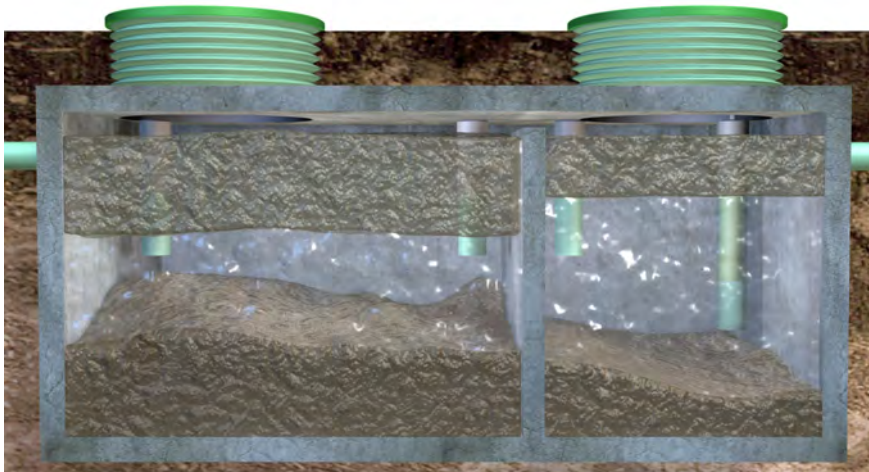

Too Full

Scum layer covering the baffle or too close to the lid of the tank means the tank is too full or the outlet baffle filter is clogged.

CALL A PROFESSIONAL TO INSPECT YOUR SEPTIC SYSTEM!

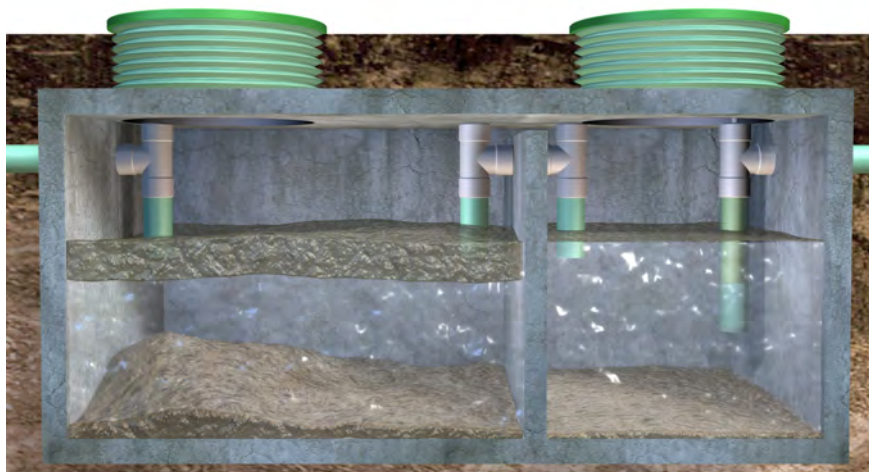

Leaking

Liquid level below the outlet pipe means a leaking tank.

CALL A PROFESSIONAL TO REPAIR OR REPLACE YOUR TANK!

Is the liquid level in your tank:

- At the base of the outlet pipe
- Above the outlet pipe
- Below the outlet pipe (tank could be leaking)

OBSERVING YOUR SEPTIC TANK

Note: If your tank has 2 chambers, perform all steps on both the inlet and outlet sides of the septic tank.



SAFETY CHECK: KEEP HEAD OUT OF RISER AND TANK WHEN CHECKING.

Check Odor: Is the tank free of strong, overpowering odor?

Yes No

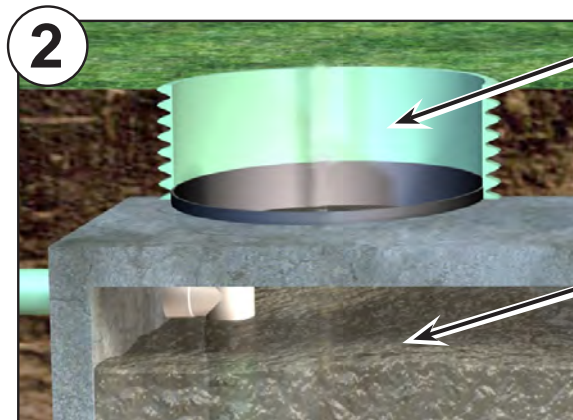

Are risers free of cracks or visible damage?

Yes No Riser Not Present

Does scum layer look like living, healthy soil?

Yes No

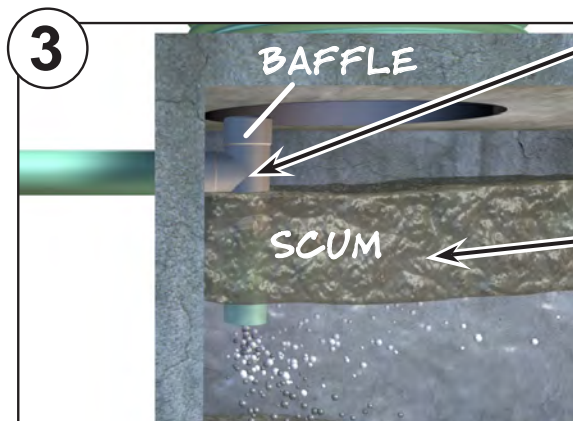

Can you clearly see baffles above scum layer?

Yes No

Is scum layer well below lid opening?

Yes No

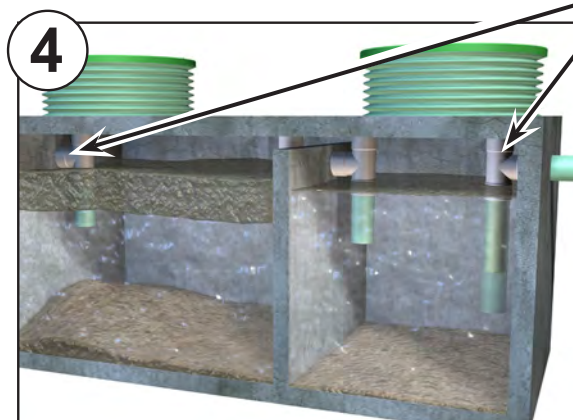

Are baffles free of clogs and leaks around the seals to the tank? If the baffle is concrete, is it intact and not corroded?

Yes No

IF YOU ANSWERED "NO" TO ANY OF THE ABOVE QUESTIONS, STOP YOUR INSPECTION AND CONTACT A PROFESSIONAL.

MEASURE THE SCUM LAYER

Note: If your tank has 2 chambers, perform all steps on both the inlet and outlet sides of the septic tank.

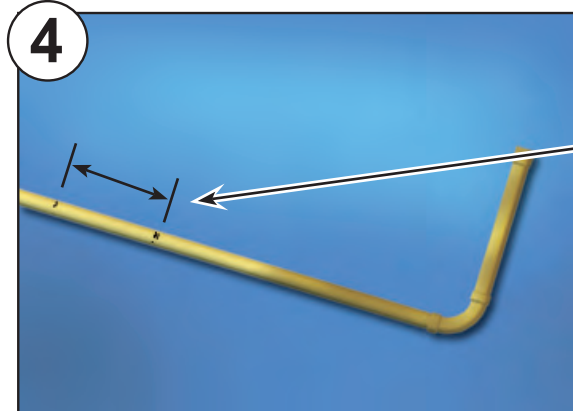
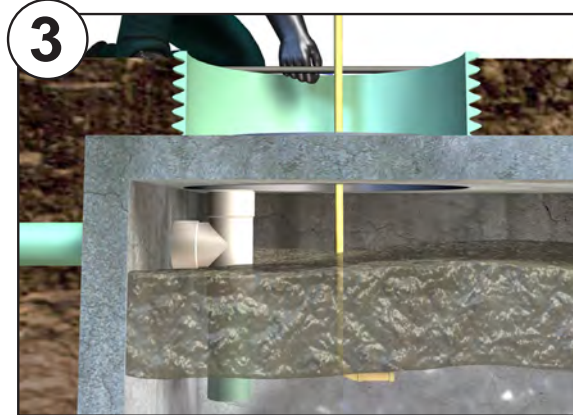
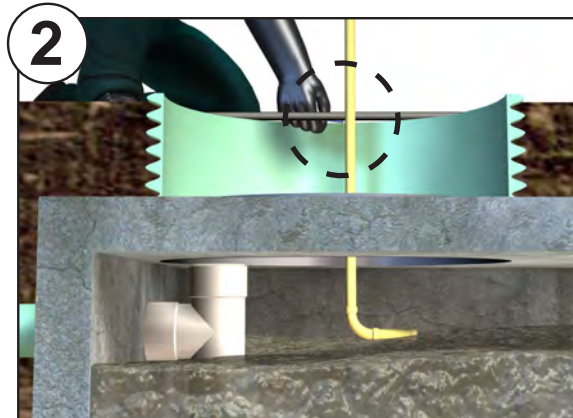
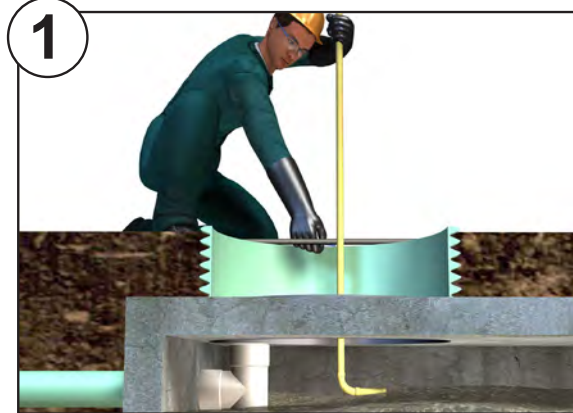

SAFETY CHECK: KEEP HEAD OUT OF RISER AND TANK WHEN CHECKING.



Place scum stick on top of scum layer.



Mark scum stick even with top of riser.



Make a hole in the scum layer and lower scum stick through hole.



Pull scum stick up until you feel the resistance of the scum layer.



Mark scum stick again, even with top of riser.



Remove the scum stick and place on a tarp.



Measure the distance between the two marks.



Mark the distance here:

Inlet Scum Depth (inches) _____

Outlet Scum Depth (inches) _____



IF SCUM LAYER IS MORE THAN 6 INCHES HAVE YOUR TANK PUMPED

MEASURE THE SLUDGE LAYER

Note: If your tank has 2 chambers, perform all steps on both the inlet and outlet sides of the septic tank.

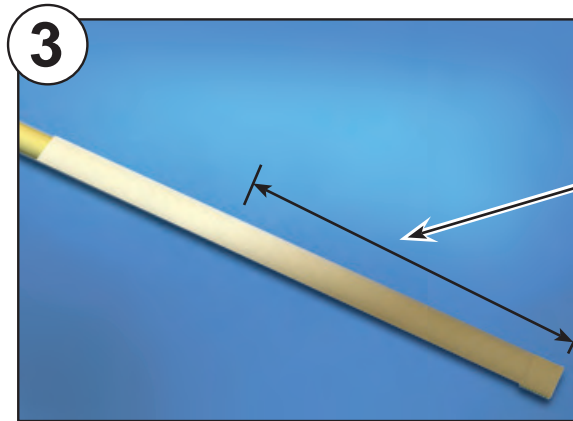
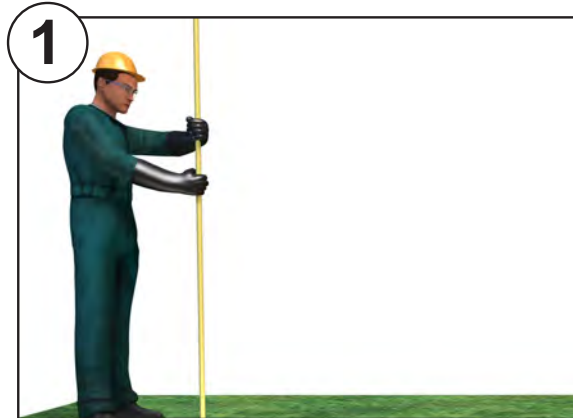

SAFETY CHECK: KEEP HEAD OUT OF RISER AND TANK WHEN CHECKING.

Carefully insert sludge stick into hole in scum or through baffle.

Lower sludge stick to bottom of tank and wait 3 minutes.

Carefully remove the sludge stick and place on a tarp.

Measure the length of the sludge stain on the Velcro.

Mark the distance here:

Inlet Sludge Depth (inches) _____

Outlet Sludge Depth (inches) _____

4 Add the scum depth (previous page) and sludge depth.

Inlet Scum Depth (inches) _____

Inlet Sludge Depth (inches) _____

Inlet Total Depth (inches) _____

Outlet Scum Depth (inches) _____

Outlet Sludge Depth (inches) _____

Outlet Total Depth (inches) _____

Does Your Tank Need Pumping? Yes No

IF THE SCUM DEPTH IS MORE THAN 6 INCHES, HAVE YOUR TANK PUMPED.

IF THE SLUDGE DEPTH IS MORE THAN 12 INCHES, HAVE YOUR TANK PUMPED.

IF THE TOTAL DEPTH IS MORE THAN 18 INCHES, HAVE YOUR TANK PUMPED.

REMOVE & CLEAN OUTLET BAFFLE FILTER

Note: If the liquid level is above the outlet pipe, contact a professional to clean the filter.

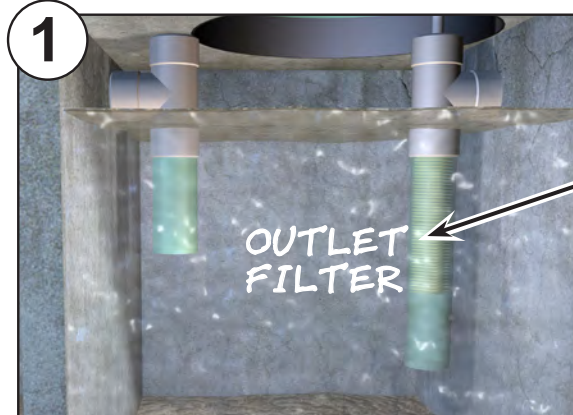

SAFETY CHECK: DO NOT REMOVE ENTIRE OUTLET BAFFLE FILTER ALL AT ONCE!



Locate the filter inside the outlet baffle.

Note: Not all systems have filters. We recommend you have one installed. Ask your local health department if a permit is required to add an outlet baffle filter.

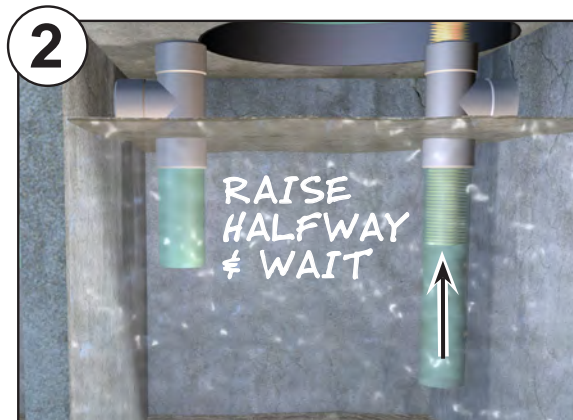

Raise outlet filter half way and let sit for 15 minutes.

This prevents any backed up effluent or loose solids from exiting the tank and damaging your drainfield.

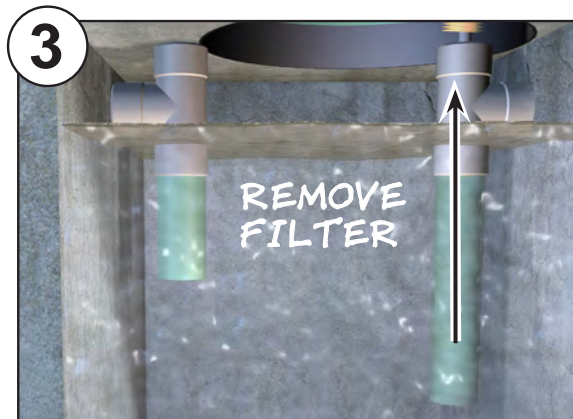

When effluent has settled, remove the filter completely.



SAFETY CHECK: AVOID SPLASHING AND CONTACT WITH SEWAGE WHILE RINSING FILTERS.



If you have a yellow "Tuf-Tite" filter, fill a bucket with water and dip filter into bucket.



Turn over and rinse.

Continued on next page...

CLEAN THE OUTLET BAFFLE FILTER



- Carefully pour out bucket into inlet side of tank.



- If you have a “sock” filter, turn it upside down and rinse it gently with a hose over the inlet side of the septic tank.

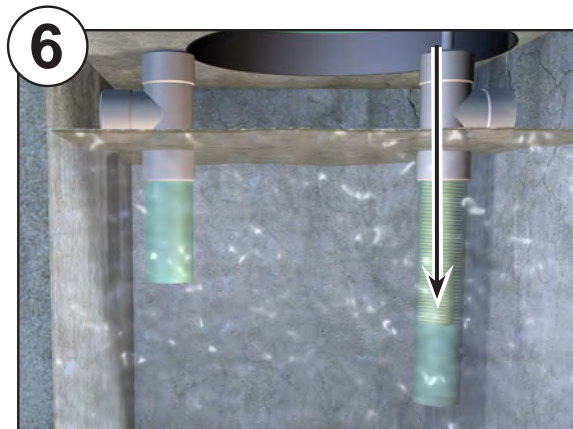

- Replace filter into outlet baffle. If replacing a Tuf-Tite filter, make sure the arrow points toward the drainfield.



- Replace and secure lids.

INSPECTING YOUR DRAINFIELD (GRAVITY SYSTEMS)

Typical Gravity Drainfield

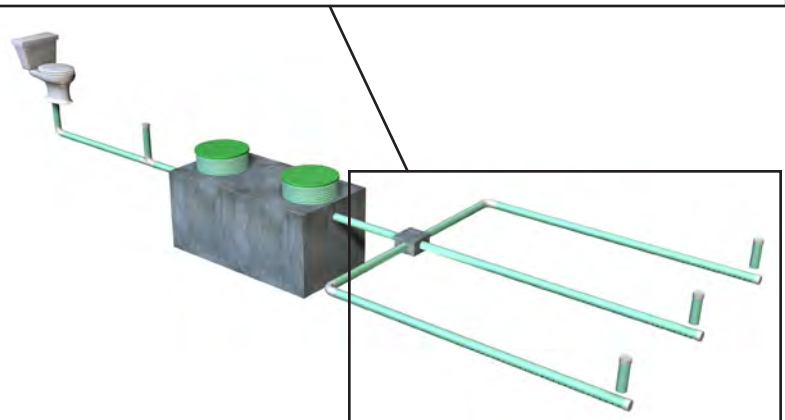
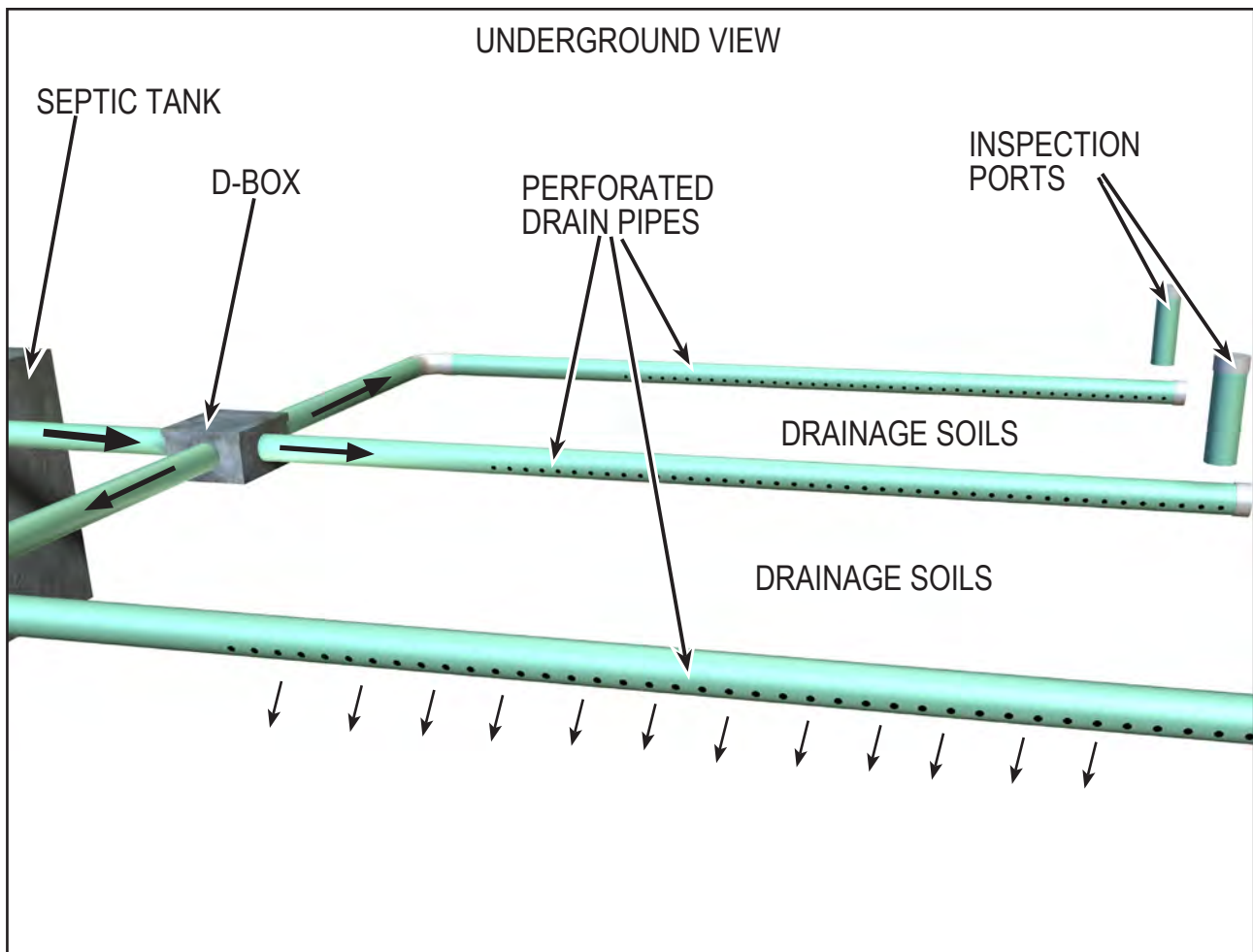

INSPECTING YOUR DRAINFIELD (GRAVITY SYSTEMS)

Note: Not all systems have inspection ports. Check the “as-built” drawing.



Walk across the entire drainfield checking for odors and damp areas.

Are there any strong odors?

Yes No



Are there any mushy or swampy areas or surfacing effluent?

Yes No



Open and look inside each inspection port (some systems). You may need a flashlight.

Is there standing water inside the inspection port(s)?

Yes No Inspection Port Not Present

Replace inspection port caps.

IF YOU ANSWERED “YES” TO ANY OF THE ABOVE QUESTIONS, STOP YOUR INSPECTION AND CONTACT A PROFESSIONAL.

INSPECTING YOUR DISTRIBUTION BOX (GRAVITY SYSTEMS ONLY)

Note: Not all gravity systems have a distribution box (D-box). Check the “as-built” drawing to determine if a D-box is used. Not all D-boxes are accessible; inspect it only if you have access to it. If it’s not accessible, consider having a professional uncover the D-box and install a riser for ease of inspection. We do not recommend a homeowner dig up their D-box. Some counties will require a permit for installing risers over D-boxes – check with your local health department.

Typical D-Box

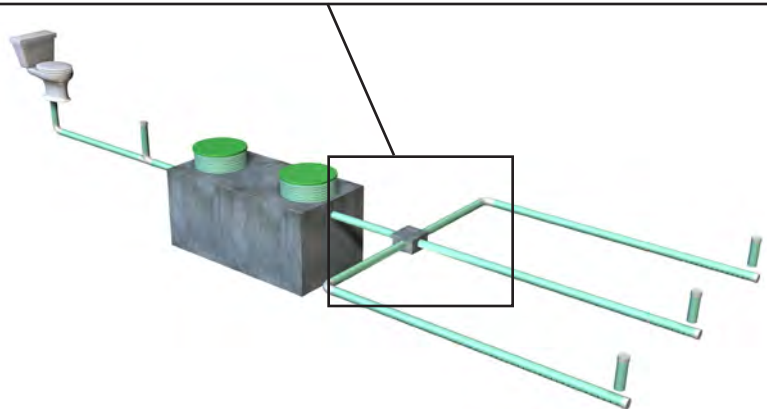
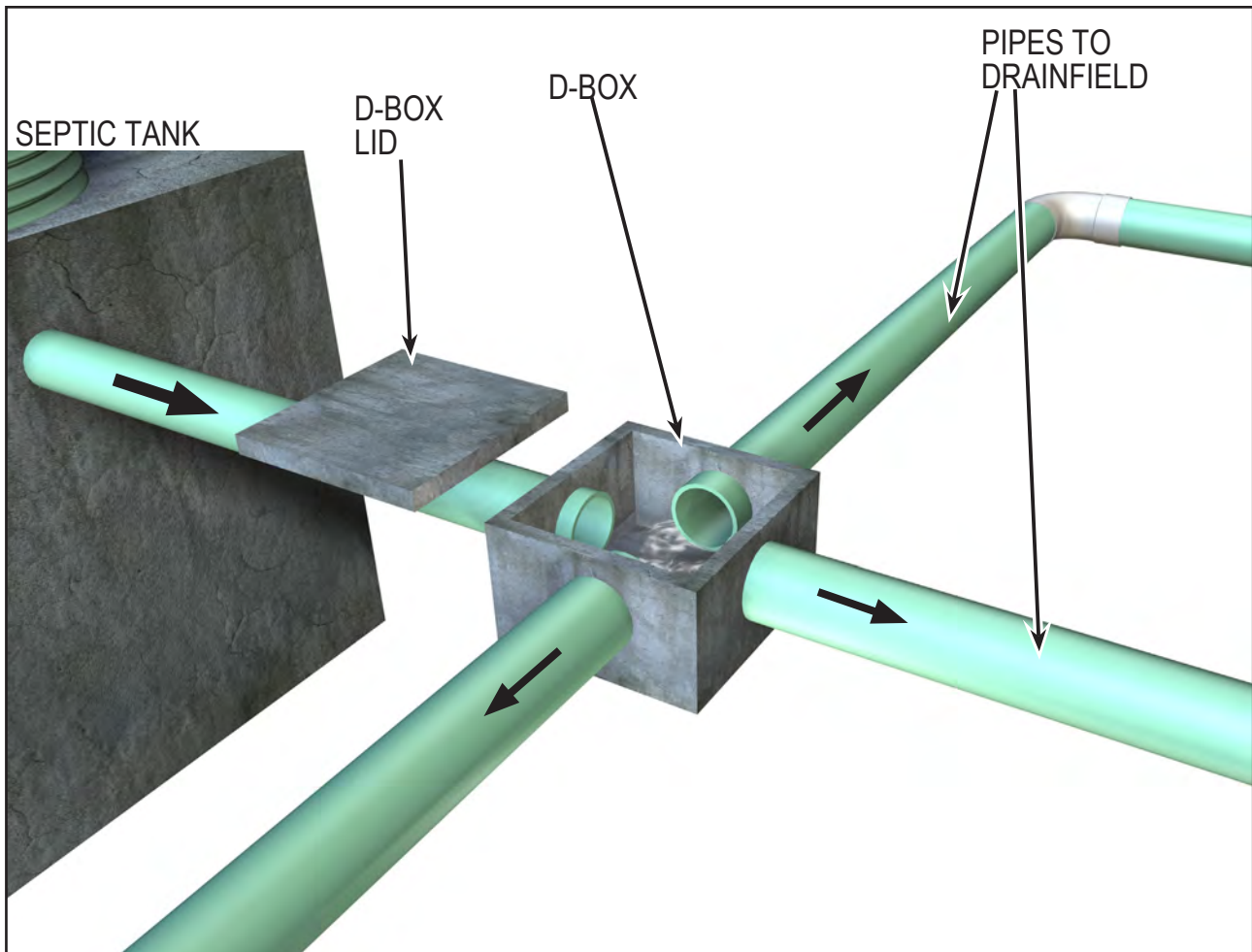

INSPECTING YOUR D-BOX

Note: If your D-Box does not have an access riser, have one professionally installed.

In some systems a D-Box will not be present.



SAFETY CHECK: USE TWO PEOPLE TO LIFT D-BOX LID.

Remove D-Box access riser lid.

Remove D-Box lid.

Is the D-Box free of solid waste and clogs?
Yes No D-Box Not Accessible/Present

Is the D-Box free from cracks and leaks?
Yes No D-Box Not Accessible/Present

Does the effluent appear to be flowing evenly into all drain pipes?
Yes No D-Box Not Accessible/Present

Gently replace D-Box lid ensuring you don't pinch fingers or disturb the D-Box.

Replace and secure riser lid.

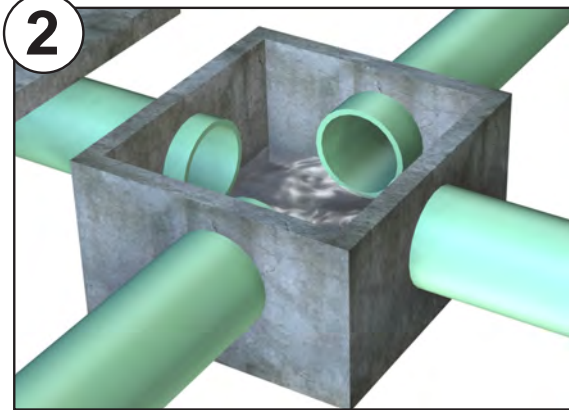

IF YOU ANSWERED "NO" TO ANY OF THE ABOVE QUESTIONS, STOP YOUR INSPECTION AND CONTACT A PROFESSIONAL.

CLEANING UP



Fill a five gallon bucket with 10 inches of water and 2 inches of bleach to make a 5:1 cleaning solution.

Wash all tools and tarp with bleach solution.



Gently pour soiled solution into inlet side of septic tank.

Replace and secure riser lids.

Discard rags in plastic trash bags.

Discard gloves in plastic trash bags.

Wash clothes with bleach.

WASH YOURSELF WITH PLENTY OF SOAP AND HOT WATER.

SEPTIC SYSTEM CARE



- Don't overwhelm your system by using too many appliances at once.
- Make sure your toilets don't leak.
- Try not to use your garbage disposal. Food waste can be bad for your system.



- Don't dispose of pharmaceuticals or hazardous household waste into your septic system.
- We don't recommend the use of septic additives.

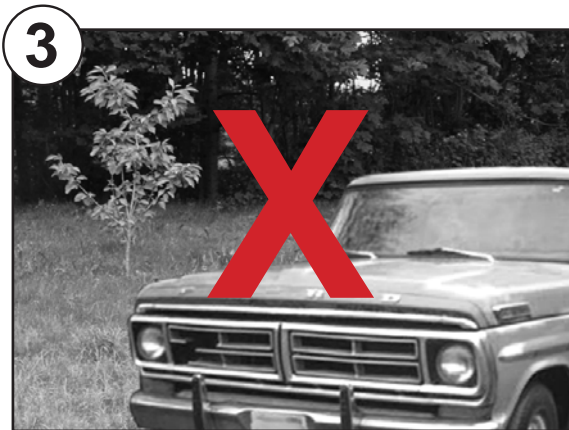

- Keep a reserve area available in case your drainfield fails.
- Don't park cars or heavy equipment or pave over your drainfield or reserve area.
- Don't put plants with deep roots over your septic system.
- Divert drain water from gutters and basement sump pumps away from the drainfield.

Glossary of Septic System Terms

(Non-Technical)

As-built or record drawing: A map available from the county that has the approximate location of permitted septic tanks and drainfield for your property.

Baffle: A short piece of vertical pipe attached to the inlets and outlets of the septic tank that prevents most solids from exiting.

Baffle Filter: A plastic filter placed in the outlet side of the septic tank that prevents small particles from entering the pump tank or drainfield.

Center Baffle: A baffle and pipe inside septic tanks that have multiple chambers which allows fluids to pass from compartment to compartment.

Distribution box (D-Box): A concrete or plastic box with a single inlet pipe and multiple outlet pipes that allows effluent (clear fluids) to be distributed evenly into different pipes in the conventional gravity drainfield.

Drainfield: A series of pipes in trenches which disperses wastewater into the surrounding soil for further treatment before it reaches the groundwater or a restrictive layer (such as hard pan or clay soil).

Effluent: The fluid that exits a septic tank, ideally clear fluids.

Float: A device that floats inside a pump tank and activates the pump via a timer or when the water level rises.

Gravity System: A septic system where effluent flows by gravity from the septic tank into the drainfield. Some gravity systems use a distribution box to distribute the effluent evenly to the drainfield trenches.

Inlet: The pipe coming from the home into the septic tank.

Inlet baffle: A pipe or plastic tee which is connected to the inlet pipe in the septic tank. The inlet baffle slows wastewater as it enters the tank and discharges sewage into the tank at the mid-point allowing solids to begin to settle out.

Mound System: An above-ground type of septic system which uses sand to pre-treat wastewater before discharging to the native soil.

On-site septic system: A septic tank and drainfield system for wastewater treatment located on properties not connected to a municipal sewer system.

Outlet: The pipe that allows fluid to exit a tank.

Outlet Baffle: A pipe or plastic tee connected to the outlet pipe in a septic tank that prevents waste solids from entering the pump tank and drainfield.

Professional: Companies or individuals that are licensed by counties and perform necessary repairs, maintenance or pumping of septic systems.

Pressure System: A septic system that uses a pump to distribute effluent evenly throughout the drainfield.

Pumping: Professional service that pumps excess solids from the septic tank.

Pump Alarm: A light and/or buzzer that warns when there is a problem in the pump tank, such as a person is using too much water, there is ground water intrusion or the pump is not operating properly. The alarm is activated by a float or a transducer (clear tube) in the pump tank.

Pump Tank: A secondary septic tank that houses an electric pump for pressurized septic systems. Sometimes needed for systems where the drainfield is uphill from the septic tank.

Riser: An extension that rises above a septic tank lid to allow easier access.

Sand filter: A pre-treatment component that is either in ground or above ground which consists of a constructed box containing a series of distribution pipes over a mix of sand and gravel. The sand filter treats the wastewater and sends treated wastewater via a pump tank to a drainfield.

Scum: The layer of solid material that floats to the top of the wastewater in a septic tank.

Scum Stick: An L-shaped stick used to measure the depth of the floating scum layer in a septic tank.

Septic Tank: An underground wastewater collection tank that allows solids to separate from wastewater so clear liquids can pass into a drainfield.

Sewage: Untreated wastewater

Sludge: The layer of solids that has sunk to the bottom of the septic tank.

Sludge Stick: A long stick or pipe with 3 feet of Velcro tape at the bottom, used to measure the depth of sludge solids in the bottom of a septic tank.

Solids: Particles that separate from wastewater in a septic tank and either sink or float.

Wastewater: Any fluids and that drain from the house into the septic tank.